

Job Name/Location:

Tag #:

Date:

For: File Resubmit
 Approval Other

PO No.:

Architect:

GC:

Engr:

Mech:

Rep:

(Company)

(Project Manager)

LS363HLV
 Single Zone Wall Mounted Extended Piping
 Outdoor Unit (ODU) - LSU363HLV Indoor Unit (IDU) - LSN363HLV



Performance:

Cooling:

Capacity (Min-Rated-Max, Btu/h)	3,070-33,000-34,000
SEER	17.5
EER	8.18

SEER - Seasonal Energy Efficiency Ratio EER - Energy Efficiency Ratio

Heating:

Capacity (Min-Rated-Max, Btu/h)	3,070-35,200-38,898
HSPF	10

HSPF - Heating Seasonal Performance Factor

Cooling Nominal Test Conditions:

Indoor: 80°F DB/67°F WB
 Outdoor: 95°F DB/75°F WB

Heating Nominal Test Conditions:

Indoor: 70°F DB/60°F WB
 Outdoor: 47°F DB/43°F WB

Electrical:

Power Supply (V ¹ /Hz/Ø)	208-230/60/1
-------------------------------------	--------------

Outdoor Unit:

MOP (A)	30
MCA (A)	19
Recommended Fuse Size (A)	25
Cooling Rated Amps (A)	14.85
Heating Rated Amps (A)	14.85
Compressor (A)	14.6
Fan Motor (A)	0.25

MOP - Maximum Overcurrent Protection MCA - Minimum Circuit Ampacity

Total Power Input:

Cooling Power Input (kW)	4.04
Heating Power Input (kW)	3.84

Piping:

Liquid Line (in, OD)	3/8
Vapor Line (in, OD)	5/8
Additional Refrigerant (oz/ft)	0.38
Max Pipe Length (ft) ²	164
Piping Length (no add'l refrigerant, ft)	24.6
Max Elevation (ft)	98.4

Controls Features:

- 24-Hour on/off timer
- 4-Way auto swing
- Auto changeover
- Auto restart
- Built-in low ambient standard, down to 14°F (cooling mode)
- Chaos wind
- Jet cool/Jet heat
- 3M HAF Filter
- Sleep mode
- Cooling only function
- Defrost control
- Inverter (variable speed compressor)
- Condensate sensor connection
- Temp display on indoor unit
- Remote control via Wi-Fi and smartphone app

Optional Accessories (sold separately):

- LG Programmable Thermostat - PREMTB10U
- Low Ambient Wind Baffle (Cooling operation to 0°F) - ZLABGP02A
- PI-485 - PMNFP14A1
- Dry contact for 3rd party thermostat - PDRYCB300

For a complete list of available accessories, contact your LG representative.

For continual product development, LG reserves the right to change specifications without notice.

© LG Electronics U.S.A., Inc., Englewood Cliffs, NJ. All rights reserved. "LG Life's Good" is a registered trademark of LG Corp. /www.lghvac.com

Operating Range:

Outdoor Unit:

Cooling (°F DB)	14-118
Heating (°F WB)	-4-65

Indoor Unit:

Cooling (°F WB)	53-75
Heating (°F DB)	60-86

Unit Data:

Refrigerant Type	R410A
Refrigerant Control	EEV
Refrigerant Charge (lbs)	4.85
ODU Sound Pressure (±3 dB(A)) ³	55
IDU Sound Pressure (H/M/L/Sleep) (±3 dB(A))	49/44/40/37
ODU Net Unit Weight (lbs)	125
ODU Shipping Weight (lbs)	133
IDU Net Unit Weight (lbs)	40
IDU Shipping Weight (lbs)	46
Heat Exchanger Coating	GoldFin™

Fan:

ODU Type	Propeller
IDU Type	Cross Flow
Fan Speeds (Fan/Cooling/Heating)	6/6/6
Quantity (ODU + IDU)	1 + 1
Motor/Drive	Brushless Digitally Controlled/Direct
ODU Max Air Flow Rate (CFM)	2,119
IDU Air Flow Max/H/M/L (CFM)	953/848/706/530
Dehumidification (pts/hr)	6.6

Notes:

1. Acceptable operating voltage: 187V-253V.
2. Piping lengths are equivalent.
3. Sound Pressure levels are tested in an anechoic chamber under ISO Standard 1996.
4. All communication/power cable to be minimum 18 AWG, 4-conductor, stranded, shielded and must comply with applicable local and national code.
5. See Engineering Manual for sensible and latent capacities.
6. Power wiring cable size must comply with the applicable local and national code.
7. The indoor unit comes with a dry helium charge.
8. This data is rated 0 ft above sea level, with 24.6 ft of refrigerant line and a 0 ft level difference between outdoor and indoor units.
9. Must follow installation instructions in the applicable LG installation manual.



Outdoor Unit (ODU) - LSU363HLV

Single Zone Wall Mounted Extended Piping



Tag #: _____

Date: _____

PO No.: _____

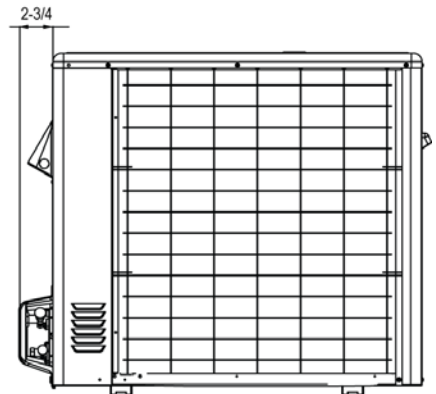
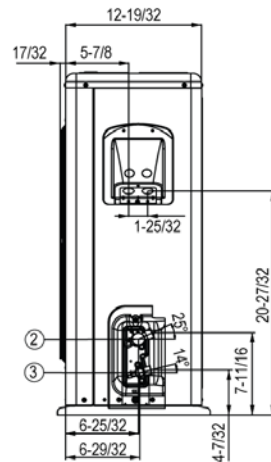
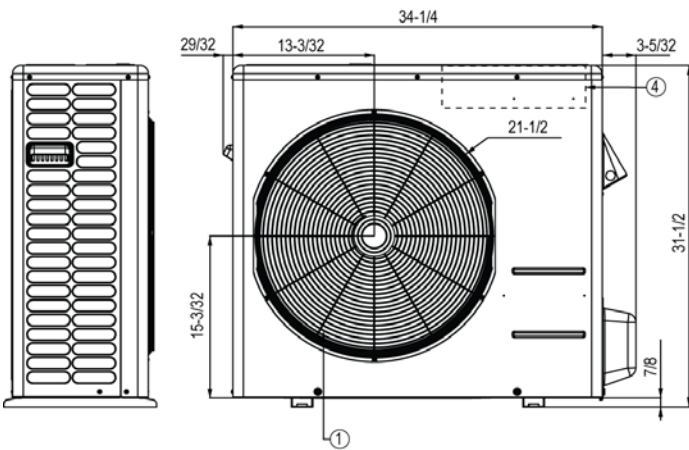
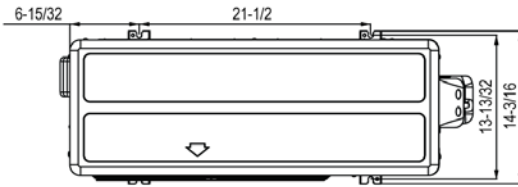
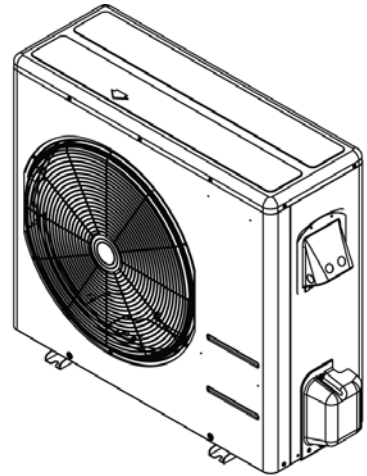
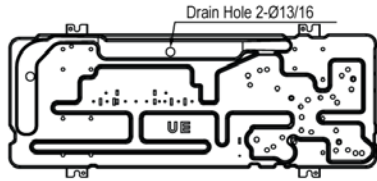

No	Part Name	Remark
1	Air Discharge Grille	
2	Gas Pipe Connection Port	
3	Liquid Pipe Connection Port	
4	Control Box	

Unit : inch (mm)

Indoor Unit (IDU) - LSN363HLV
 Single Zone Wall Mounted Extended Piping



Tag #: _____
 Date: _____
 PO No.: _____

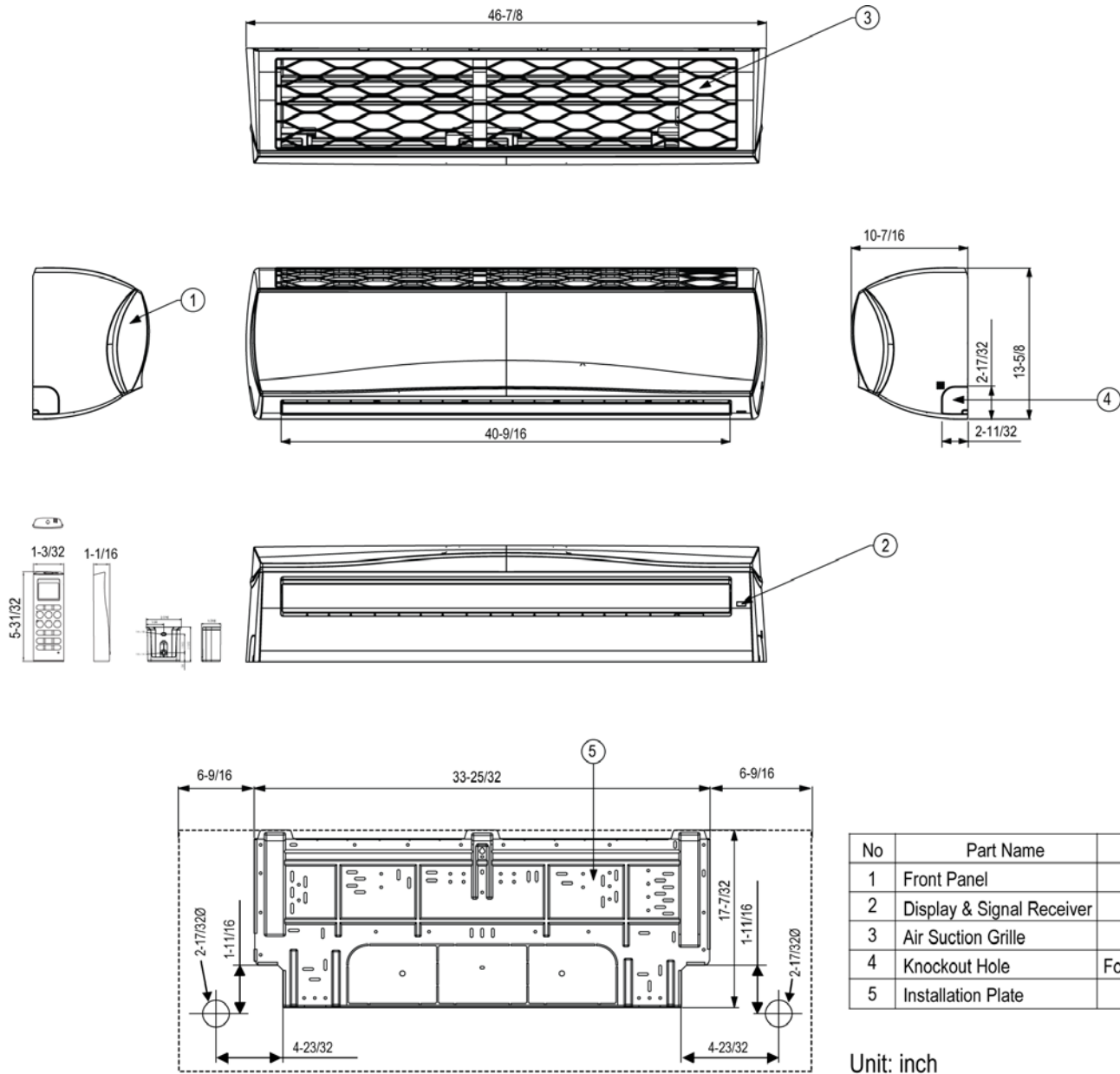

No	Part Name	Remark
1	Front Panel	
2	Display & Signal Receiver	
3	Air Suction Grille	
4	Knockout Hole	For pipe and cable
5	Installation Plate	

Unit: inch